

# 5

MyChron5 - MyChron5 2T  
MyChron5S - MyChron5S 2T

USER GUIDE 1.03



[www.aim-sportline.com](http://www.aim-sportline.com)





# MYCHRON5

Twenty years ago we installed the first MyChron...

The original simple concept of a personal chronograph automatically showing lap times and other important information to the racer remained the core of the system, that, in the meantime, has improved and improved till arriving to the fifth generation.

Introducing now MyChron5, we are deeply grateful to all of you, that have followed us during all this time, in all the tracks of the world, in every category, in every country.

We are deeply grateful to all our dealers, distributors, friends that have spent their lives on the track, attending our systems, helping everybody to start using them, repairing them when they required to be repaired, giving us important feedbacks that allowed us to improve them constantly in all these years.

Thank you.



# MyChron5

INDEX			
<b>01 – MyChron5 in a few words</b>	<b>04</b>		
<b>02 – What is in the kit</b>	<b>08</b>		
<b>03 – Installation and powering</b>	<b>12</b>		
3.1 – Installing the RPM cable on a four-stroke engine	<b>13</b>		
3.2 – Installing the RPM cable on a two-stroke engine	<b>14</b>		
3.3 – Recharge and powering	<b>15</b>		
<b>04 – Configuration menu</b>	<b>18</b>		
4.1 – Configuration Wizard	<b>19</b>		
4.2 – Backlight	<b>20</b>		
4.3 – System settings	<b>21</b>		
4.3.1 – Measure unit	<b>21</b>		
4.3.2 – Drive setup	<b>21</b>		
4.3.3 – RPM setup	<b>23</b>		
4.3.4 – Lap time setup	<b>24</b>		
4.3.5 – LED setup	<b>26</b>		
4.3.6 – Display setup	<b>28</b>		
4.3.7 – General settings	<b>30</b>		
4.3.8 – System info	<b>30</b>		
4.4 – Counters	<b>31</b>		
4.5 – Date time	<b>32</b>		
		4.6 – Wi-Fi	<b>33</b>
		4.6.1 – Configuring MyChron5 as an Access Point (AP)	<b>36</b>
		4.6.2 – Adding MyChron5 to an existing network	<b>39</b>
		4.6.3 – Wi-Fi network settings	<b>42</b>
		4.6.4 – The Internet connectivity	<b>44</b>
		4.6.5 – Connection issues	<b>44</b>
		4.6.6 – Working on Mac™ with virtualized Windows™	<b>45</b>
		4.6.7 – Connected device visualization issues	<b>48</b>
		4.7 – GPS and Track management	<b>49</b>
		4.7.1 – Creating a track with MyChron5	<b>50</b>
		4.8 – Language	<b>51</b>
		4.9 – Clear memory	<b>51</b>
		<b>05 – On the track</b>	<b>52</b>
		<b>06 – Data Recall</b>	<b>54</b>
		6.1 – Data recall in Road racing mode	<b>54</b>
		6.2 – Data recall in oval racing mode (US version only)	<b>56</b>
		<b>07 – Connection to the PC</b>	<b>59</b>
		<b>08 – Data download</b>	<b>61</b>
		<b>09 – Analysis</b>	<b>62</b>
		<b>10 – Notification of new available versions</b>	<b>64</b>
		<b>11 – Technical specifications and drawings</b>	<b>66</b>

# 1. MyChron5 in a few words

MyChron5 is a gauge designed for being installed on a kart.

**Please note:** this user guide applies to all MyChron5 products, to say:

- MyChron5 / MyChron5S
- MyChron5 2T / MyChron5S 2T



It samples and shows:

- RPM from the sparkplug cable, 20 or 50 times per second
- A temperature value (2T models manages two temperature values) . It can be exhaust gas, cylinder head or water temperature.

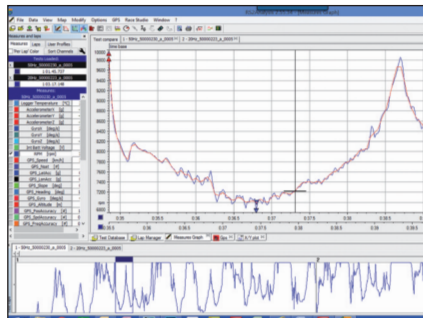

■ All parameters coming from GPS and Glonass constellations: speed, position, lateral acceleration and time of the day with a precision of one millisecond.

The receiver has been tuned for our sport and can thereby stand all lateral and longitudinal accelerations, direction changes and vibrations without problems, always giving a perfect result ten times per second (10 Hz) on MyChron5/2T and 25 times per second (25Hz) on MyChron5S/S2T. MyChron5 uses both GPS and Glonass data to compute lap times.



Its database includes more than 1500 tracks, thereby automatically recognizing the track you are racing on, its start/finish line, the possible splits and calculating lap/split times with high precision.

All these data are stored in a huge 4GB internal memory, that can record your data for thousands of hours.

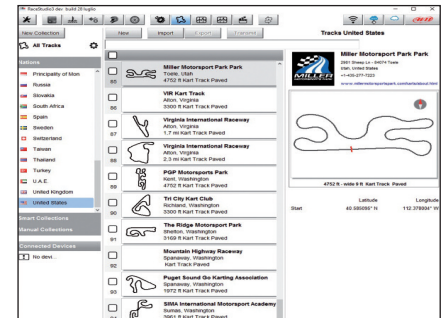

You can download the data recorded on your PC using Wi-Fi.

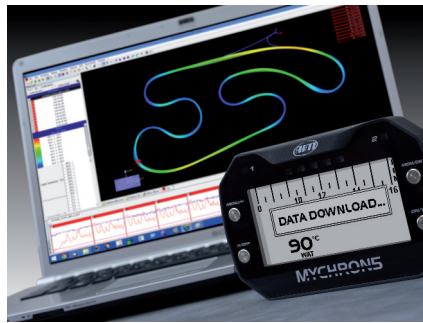

Finally, you may analyse the data with Race Studio Analysis, the widely approved data software you can freely download from our website [www.aim-sportline.com](http://www.aim-sportline.com).

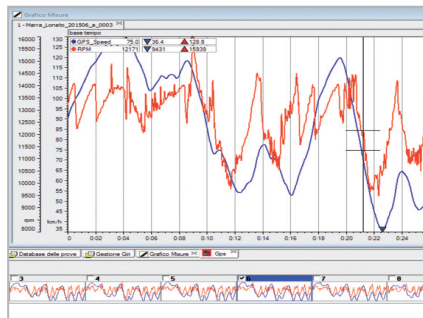

The wide LCD display has a freely configurable RGB backlight and a light sensor that automatically switches on the backlight with low light conditions. The two RGB alarm LEDs can be switched on with seven different colours, different blinking patterns and custom temperatures thresholds.



Five configurable shift lights help you choosing the best up-shift moment.

A very helpful alternative is to use them to indicate the real-time gap between the current lap and the best lap of the session.

MyChron5 is powered by an internal rechargeable three Amp lithium ion battery included in the kit and supplied with its charger.



The battery powers the system for up to ten hours.

You can also power MyChron5 with a 12V external battery (3 or 4 cells LiPo type too).

MyChron5 is expandable: you can connect it via CAN bus to:

- SmartyCam HD
- LCU-One CAN Lambda controller
- MyChron Expansion
- Infrared Temperature controller

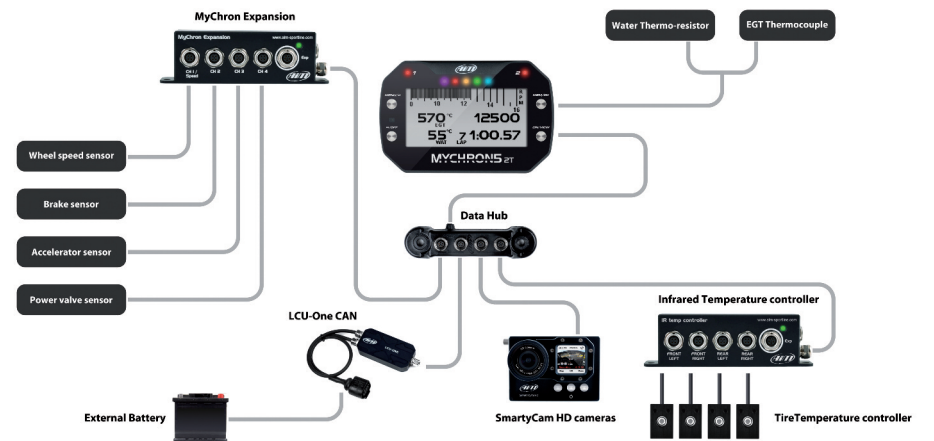

## 2. What is in the kit?

- 1 MyChron5
- 2 RPM cable
- 3 Temperature sensor
- 4 Battery Charger with cable

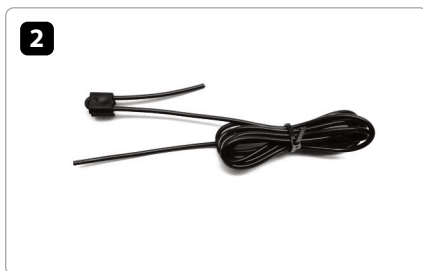
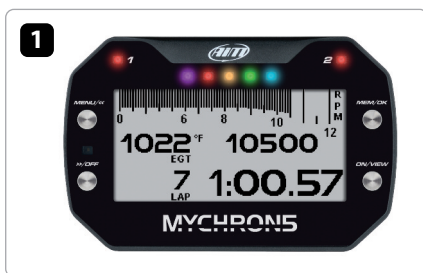

MyChron5

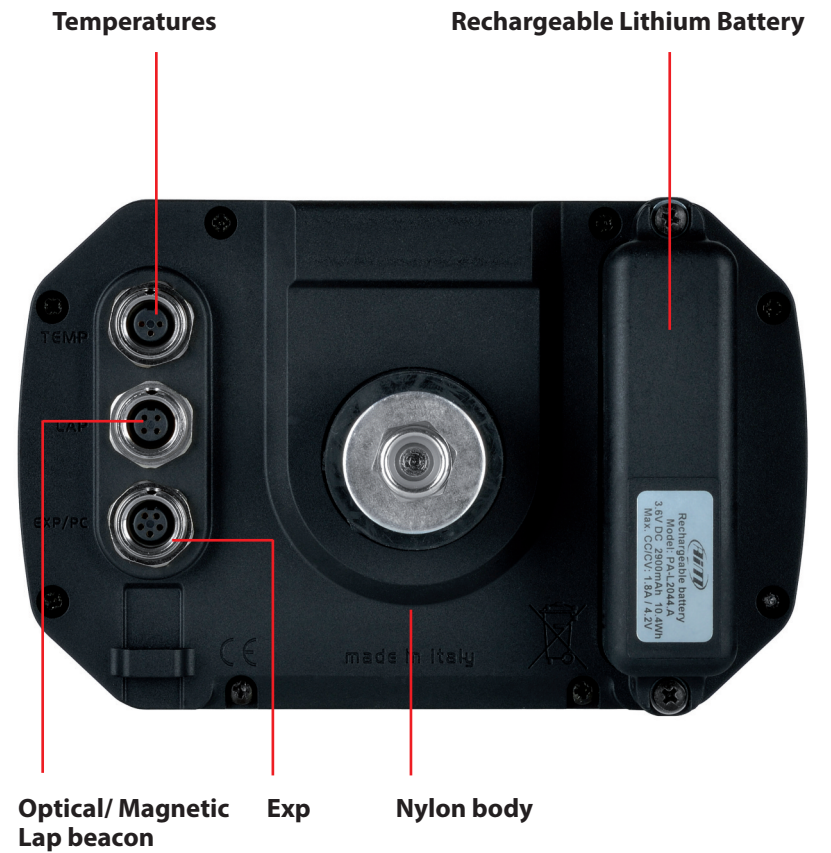
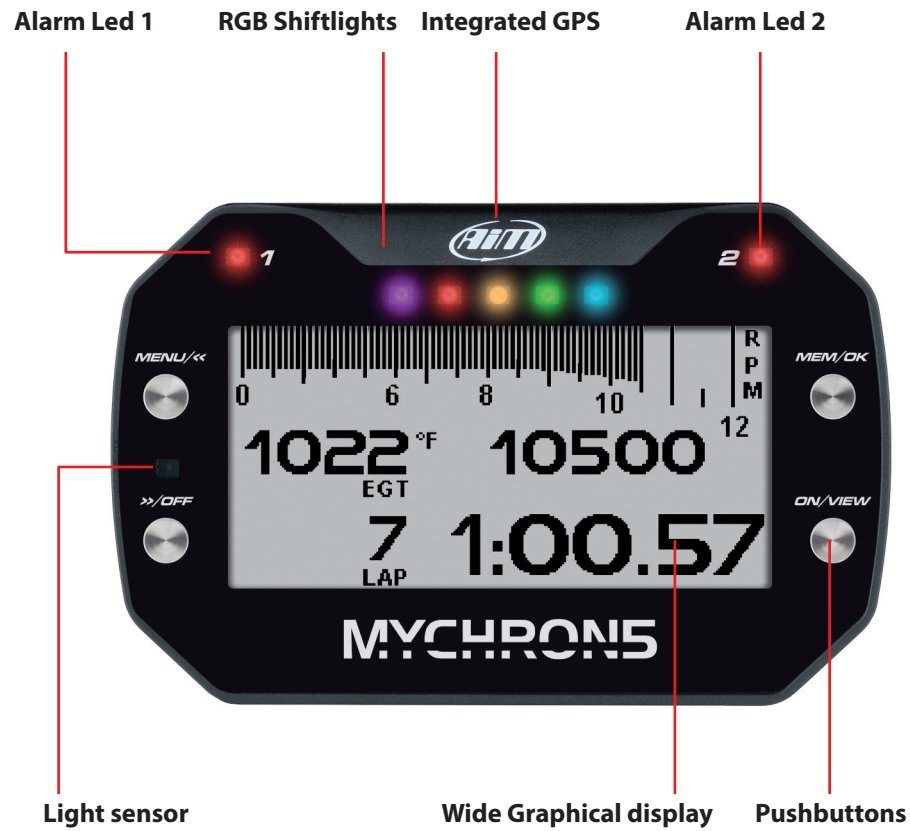

### 3. Installation and powering

Your MyChron5 has been designed to be installed on a kart steering wheel. Please install rubber washers above and under your kart steering wheel as shown in the central and right images here below.

When installing the harness be careful not to over tighten the plastic stripes – this because vibrations can cut the harness sheath – and leave the cable long enough to stand the steering wheel angle.

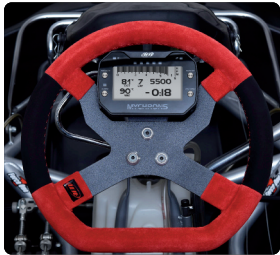

#### Temperature sensor Installation

When installing sensors ensure that the sensor cable does not bend as in the left image below.



### 3.1 Installing the RPM cable on a four-stroke engine

A clean RPM signal is the key of a good performance of your MyChron5.

To get a clean signal, it is important for the RPM lead be installed correctly in order to pick up a strong signal from the plug wire

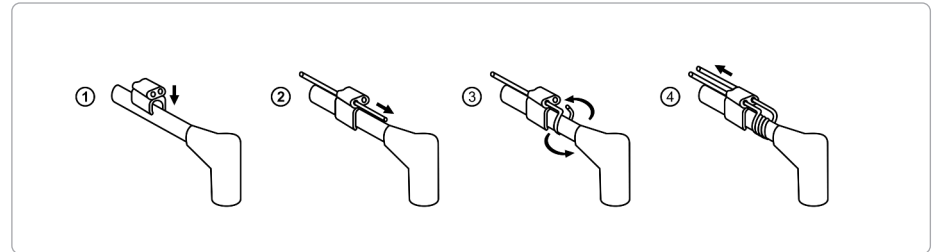

*MyChron Mike, a true legend in the kart world*



"Do not run the RPM lead in any type of tubing; it should be run right along the frame rail.

Take care not to overtighten the tie wraps. If your lead is too long, don't coil it up; just cut the tach end to length. At the tach end, make sure that the lead loops through the two small holes and then extends out about half an inch and then use a small tie wrap to keep it snug.

It is very important to pull the RPM wire about four inches through one side of the clip then wrap the wire around your plug lead a couple of times and back through the opposite side of the clip."



## 3.2 Installing the RPM cable on a two-stroke engine

Make the RPM cable pass in the clip without wrappings on the spark wire as shown here below (4).

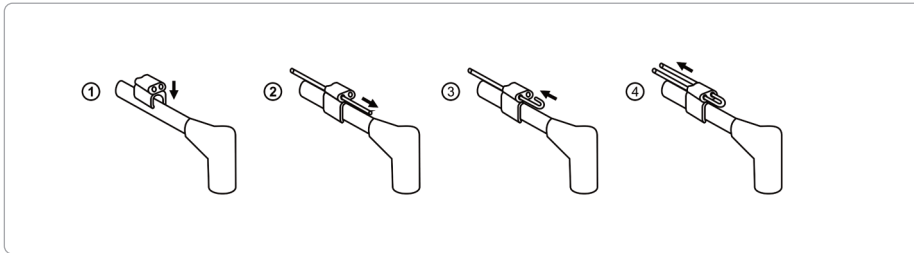

## 3.3 Recharge and powering

MyChron5 can be recharged in three ways:

- through a wall adapter, using the charger included in the kit; this solution is ideal if you use multiple batteries in rotation and if MyChron5 is installed far from a socket.

The available versions part numbers are:

- X80M5KCBUSB1E (EU)
- X80M5KCBUSB1U (USA)
- X80M5KCBUSB1G (UK)
- X80M5KCBUSB1A (AUS)



- directly to a wall adapter thanks to the proper charger available as optional in different versions for different countries; this is ideal if a socket is available nearby the kart.

The available versions part numbers are:

- X06A12VBME (EU)
- X06A12VBMU (USA)
- X06A12VBMG (UK)
- X06A12VBMA (AUS)



- with a 12V external battery (also LiPo 3-4 cells) using the external power cable available as optional.

This situation allows you to recharge the battery while keeping the system powered, so obtaining a longer autonomy. In this case you can also remove the lithium battery that is not being used and apply an optional aluminium cover to protect the power connectors.

Optional items part numbers are

- connection cable V02557020
- aluminum protection: X80MY5TPB

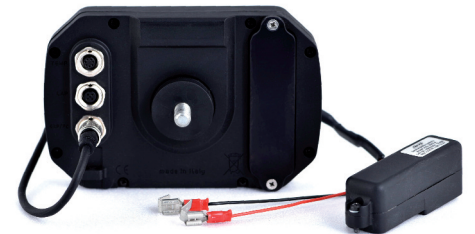

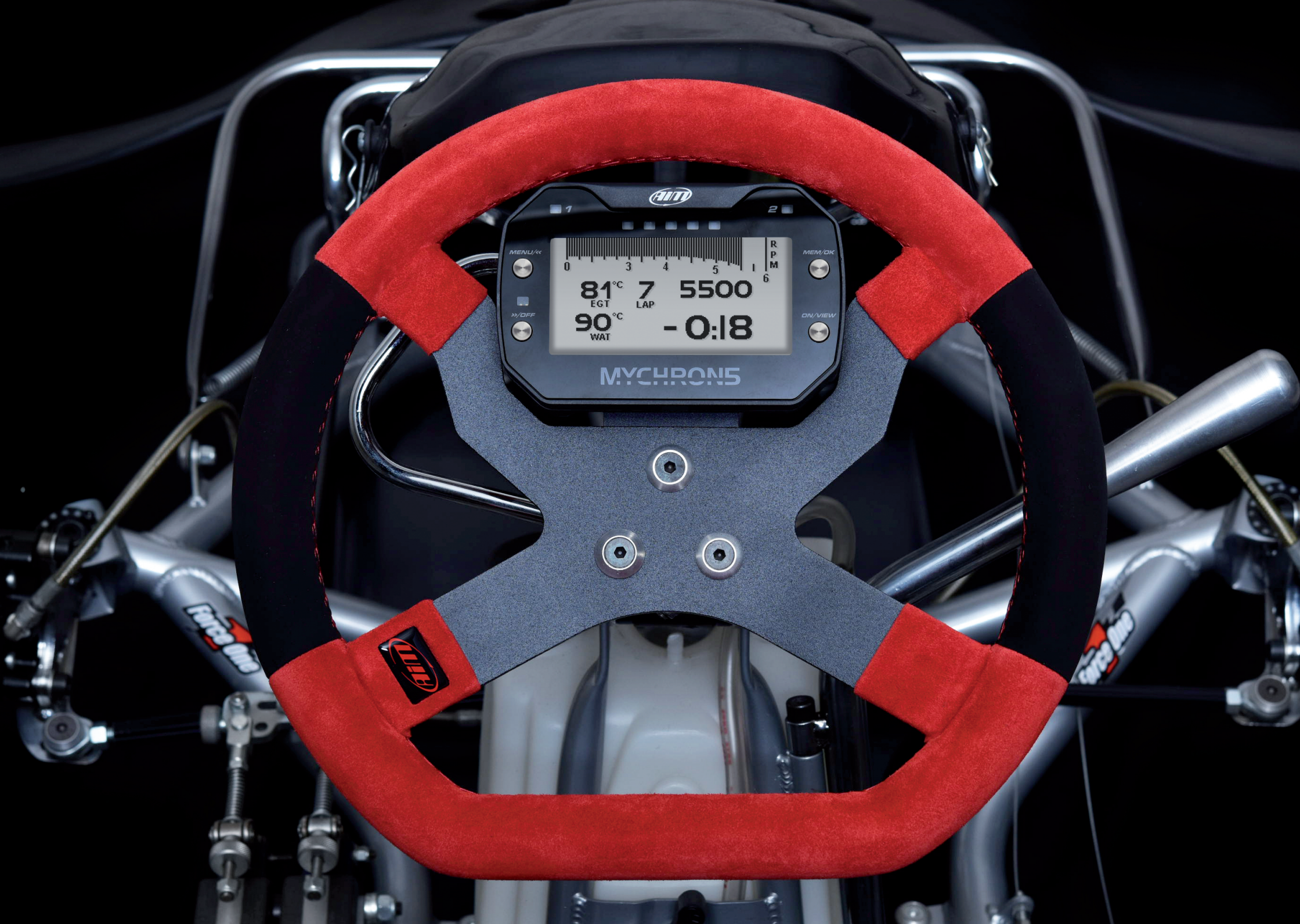

AIM

1 2

MENU/OK

MENU/OK

M/OFF

ON/VIEW



MYCHRON5

AIM

Force One

## 4. Configuration Menu

Before using your MyChron5 you need to set some parameters as explained here below. Enter the menu pressing the "MENU/←" button and this page shows up.

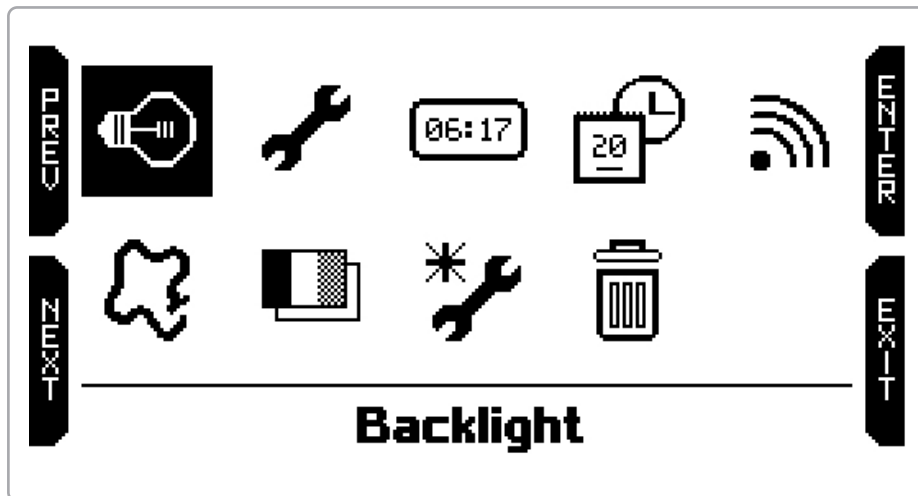

The icons allow you to set your MyChron5 up:

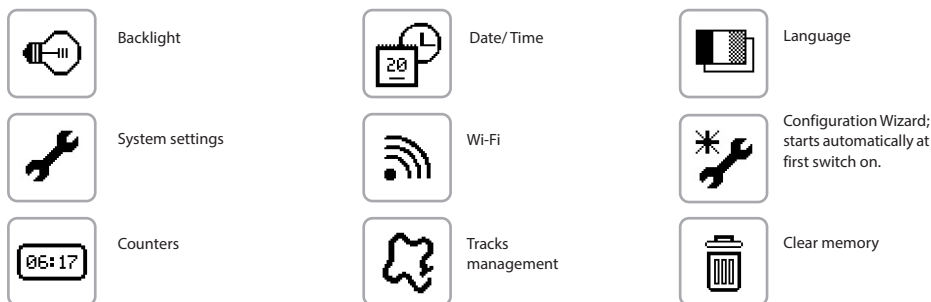

## 4.1 Configuration Wizard



Configuration wizard starts automatically at the very first switch on. It helps you setting your MyChron5 main parameters:

- language
- temperature measure unit (Fahrenheit or Celsius)
- speed measure unit (mph or km/h)
- RPM full scale
- drive setup (direct, clutch or gearbox)
- type of race: Road racing or Oval (this choice is only available in the US version)

Road and oval racing show different information when crossing the start/finish line and at data recall. When crossing start/finish line:

■ In Road Racing MyChron5 shows:

- max/min temperature(s) values
- max/min RPM values
- lap number
- lap time

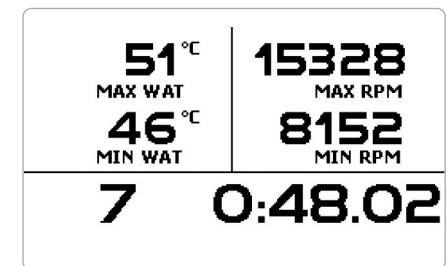

■ In Oval racing MyChron5 shows:

- max/min temperature(s) values
- RPM drop (difference between max and min RPM values)
- lap time

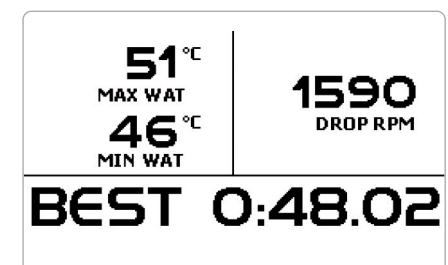

## 4.2 Backlight



You can set the backlight as "ON", "OFF" or "AUTO". In this last case the light sensor placed left on the front of your MyChron5 switches on/off the backlight according to the ambient light level.

In this page you can also change the backlight colour choosing among eight different colours



## 4.3 System settings



Selecting this icon you enter MyChron5 main configuration page.

Here you find RPM, gear, LED, display and lap configuration menus.

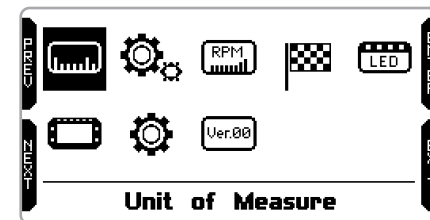

### 4.3.1 Measure unit



You can set the unit of measure of:

- speed: km/h or mph
- temperature: °C or °F

### 4.3.2 Drive setup



Settings are different according to the system version and to the type of race you set.

European version and US version road racing offers these options:

- clutch
- direct
- gearbox (it needs gear calculation procedure)

To perform gear calculation

- fill in the highest gear number
- run a learning lap
- if the calculation is not correctly performed press "Reset Gear Calc" and repeat it.

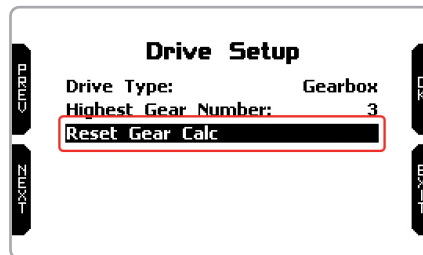
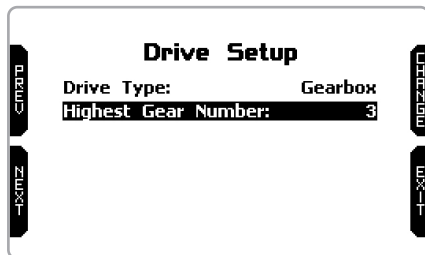

Further information about gear calculation and learning lap procedure are available on the website [www.aim-sportline.com](http://www.aim-sportline.com) – Download Area – Documentation – MyChron5 section.

**US version – Oval racing** offers these choices:

- Direct
- Clutch

### 4.3.3 RPM setup



You can set:

- RPM full scale (from 6000 to 24000)
- RPM frequency (20Hz or 50Hz)
- RPM factor (x1, x2, /2, /4, /3)

RPM can be read 20 or 50 times per second (20 or 50 Hz) according to your needs. 20Hz reading provides a cleaner signal thus making it easier to recognize the RPM trend while 50Hz reading allows you to better recognize the chassis vibrations that can affect the kart ideal movement. The image below shows both sampling.

RPM factor is the ratio between the number of ignitions and the number of crankshaft revolutions. Kart typical setting is "x1"; other installations can need other factors.

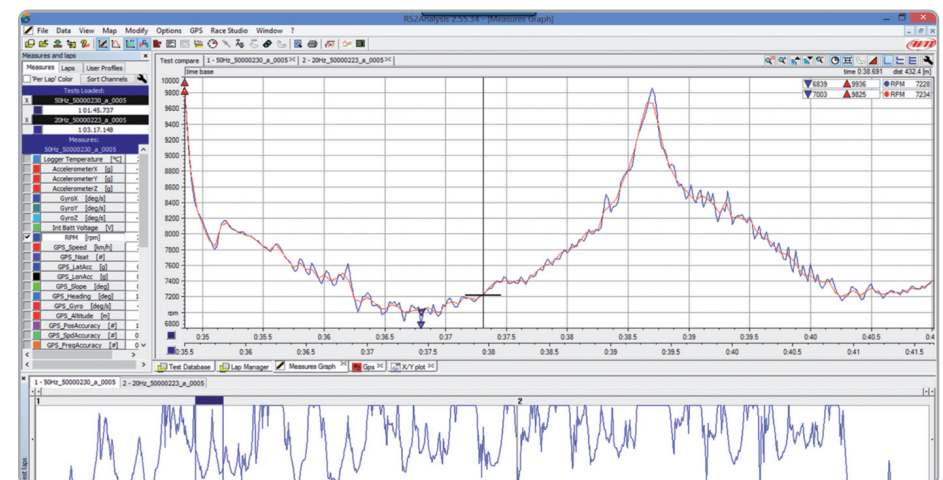

## 4.3.4 Lap time setup



Settings change according to MyChron5 version.

**European version:** you can set different lap management:

- automatic (left image below)
- manual (right image below): you can choose GPS or optical/magnetic receiver

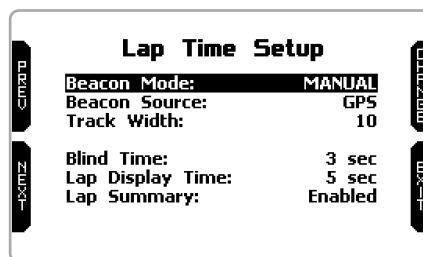
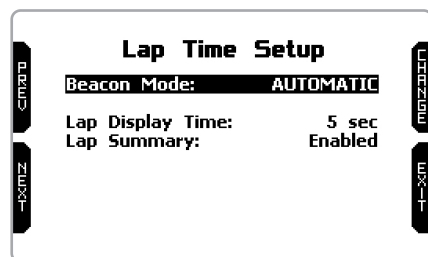

In **automatic mode** MyChron5 recognizes if an optical/magnetic receiver is connected in addition to the integrated GPS. In this case both receivers work at the same time continuously exchanging and comparing information about track finish and split points you cross. You can:

- show lap time when crossing start/finish line for a 3-60 seconds time period.
- enable/disable lap summary visualization when crossing start/finish line; in the US version only what is shown depends on the type of race you set in the Wizard or in the general settings (Road or Oval).

In **manual mode** MyChron5 default setting is GPS lap time but you can also set magnetic/optical receiver (right image below).

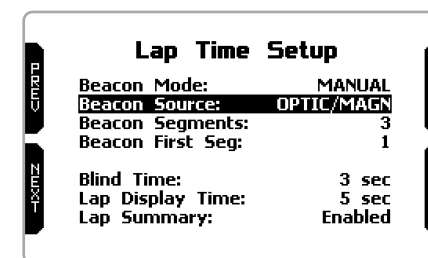
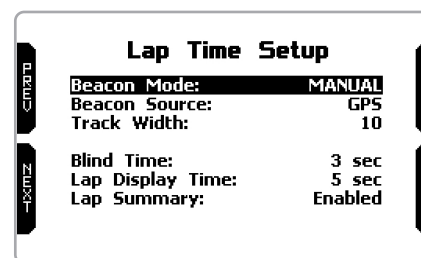

For GPS lap time you need to:

- fill in track width (between 5 and 100m)
- set blind and lap display time (both between 3 and 60 seconds)
- enable/disable lap summary visualization when crossing start/finish line.

For optical/magnetic lap time you need to:  
(EU version)

- fill in the number of beacon segments (between 1 and 6)
- set beacon first segment
- set blind and lap display time (between 3 and 60 seconds)
- enable/disable lap summary visualization or not when crossing start/finish line.

(US version)

- set lap display time when crossing start/finish line (from 3 to 60 seconds)
- enable/disable lap summary visualization; as already said the data shown changes according to the type of race you set.

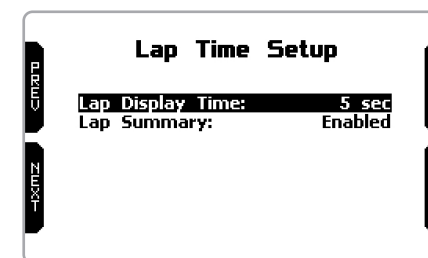

### 4.3.5 LED setup

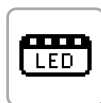

Here you can set:

- the central LEDs bar (LED Bar)
- the two lateral LED corresponding to "1" and "2" screen prints (Alarm LEDs)

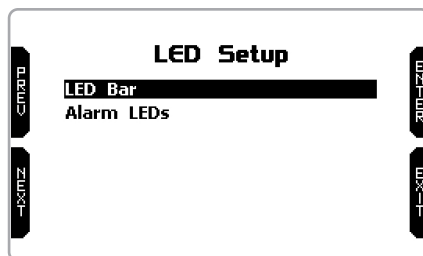

Choosing "RPM" (left image below) you can set RPM threshold value (up to 16.000) that switches on each LED so to know when shifting. Choosing "OFF" the central LED bar is disabled.

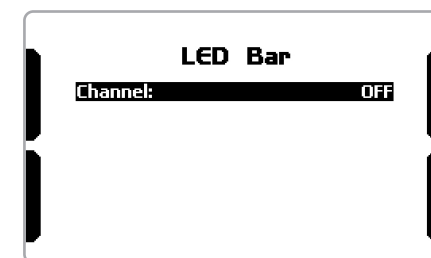
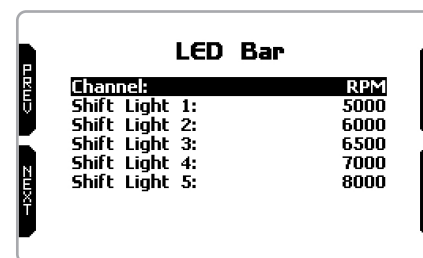

**LED Bar:** manages the central LEDs that can indicate:

- Laptime
- RPM
- OFF

Choosing Laptime LEDs will switch on while running showing:

- gap between current lap time and best lap time (Predictive)
- gap between current split time and this split time in best lap (Best Section).

Each of the five LEDs indicates a tenth of a second gap; if lighting green they indicate an improvement of current lap compared to best lap of this session while if lighting red they indicate a worsening.

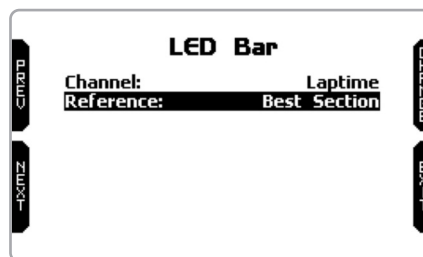
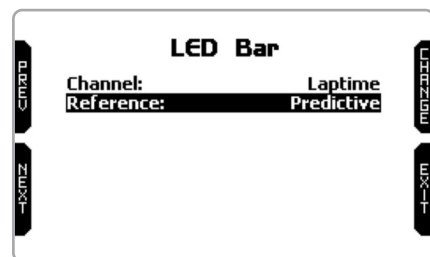

**Alarm LEDs:** manages the lateral LEDs corresponding to "1" and "2" screen prints that can be configured as alarms (left image below).

Entering the page (right image below) you can link each LED to a temperature sensor and set it switching on threshold, LED colour and blinking frequency.

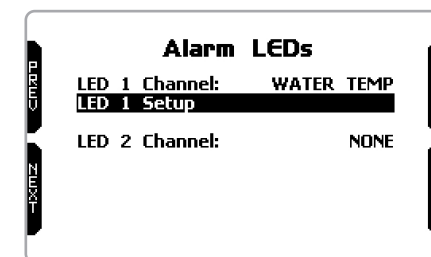
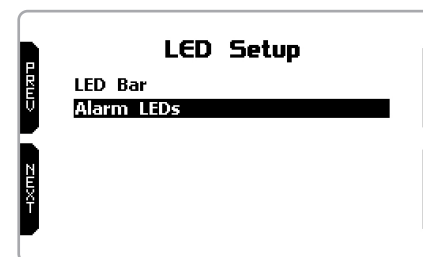

### 4.3.6 Display setup



MyChron5 can show up to 6 pages, two of which are pre-defined and four custom. **Pre-defined** pages, enabled by default, are:

- RPM&Lap Time (left image here below): shows RPM value and lap time (and split time if set) other than temperature(s);
- Speed&Lap Time (right): works exactly like the previous one but shows speed.

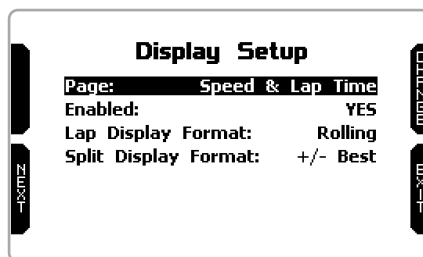
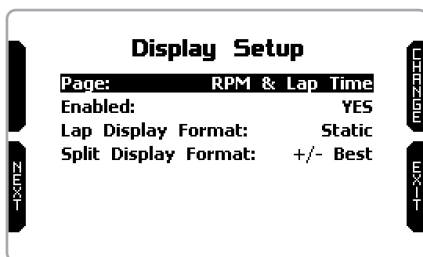

In both pages you can see lap time in three formats:

- static: shown steady for the entire lap; changes when crossing start/finish line;
- rolling: dynamic, is shown for the time period you set in "Lap Time setup" (see related paragraph); afterwards time starts rolling again;
- +/- best: shows the gap between current lap and the best lap of this session; if the current lap is the new best lap this is automatically updated and becomes the reference for the following laps;
- predictive: it calculates each 50m the predicted lap time using the speed channel and GPS position.

If you set split time you can see it in two formats:

- actual: shows current split time;
- +/- best: shows the difference between current split time and best time of that split in the current session (not always related to the best lap).

The four **custom** pages need to be enabled as shown below. Enabling them "CONFIG" button top left of the page appears: press it.

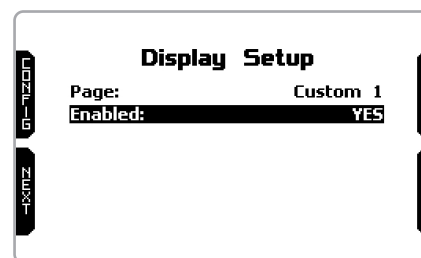

Each custom page can show up to four fields. Pressing "SELECT" you can choose the channel to show in each field. The only field that can show lap time in different formats is bottom right one (right image below).

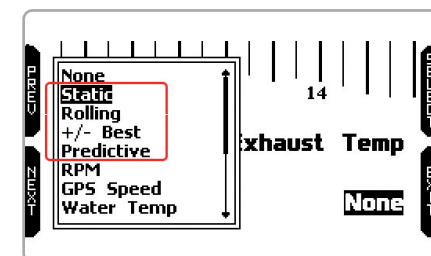
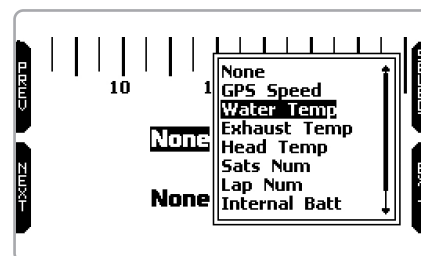



### 4.3.7 General settings



In the **European version** you can enable/disable GPS.

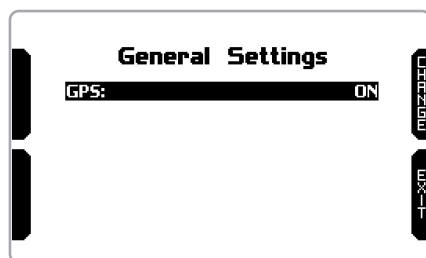

In the **US version** you can select the type of race choosing between oval and road.

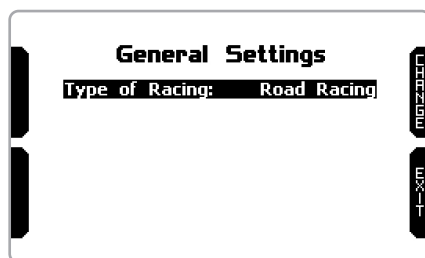

### 4.3.8 System info

This page shows serial number as well as firmware and Boot version of your MyChron5.

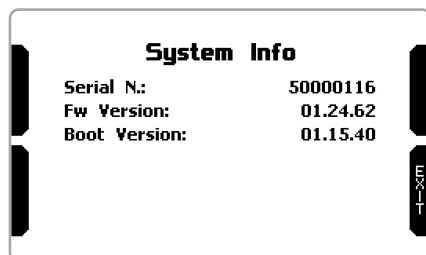

### 4.4 Counters



This page manages the 4 resettable odometers of MyChron5. The system odometer is not resettable and is not shown; you will see it in odometers page of Race Studio 3 software (see the chapter about MyChron5 and the PC).

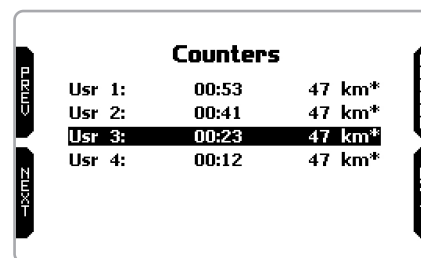

Each odometer can be activated/deactivated and/or reset. Select the odometer you want to manage and press "CHANGE":

- to disable select "Status" and press "CHANGE": status becomes "STOP" (left image below)

- to reset the odometer select "Clear" and press "CHANGE" (left image below)

- pressing "EXIT" you go back to counters page and won't see the asterisk on the counter you disabled while the cleared one shows 0 km (in the right image below both operations have been performed on counter 3).

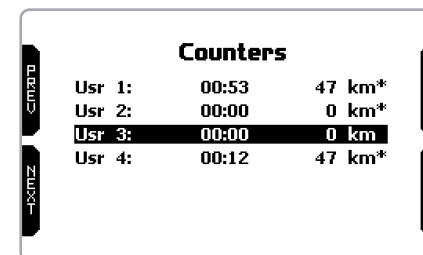
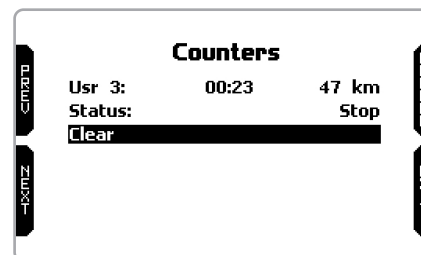

## 4.5 Date time



Here you can set the time zone of your MyChron5 as well as enable/disable “Daylight Saving Time”. Time zone is always set manually. Date and time can be shown in different formats.

Time is automatically synchronized as MyChron5 receives the GPS signal.



## 4.6 Wi-Fi



Here you can manage Wi-Fi as well as reset its configuration. In the **US version** available Wi-Fi modes are:

- ON
- auto
- OFF (default)

In the **European version** available Wi-Fi modes are:

- auto
- OFF (default)

In this version “ON” mode is not available.

In **both versions** “AUTO” mode switches Wi-Fi on when the kart is stopped and automatically **switches it off** when the kart starts recording (RPM value higher than 850).

“**WiFi Reset CFG**” option allows to reset Wi-Fi configurations and is very useful if you do not remember Wi-Fi password.

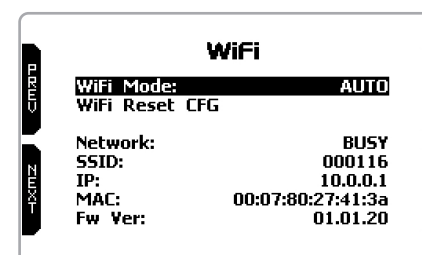

MyChron5 Wi-Fi configuration can be made only using Race Studio 3 software. Two possible Wi-Fi modes are available:

### 1 – As an Access Point (AP – default setting)

This is the ideal configuration if you have one only device and one only computer. In this situation, your MyChron5 creates a Wi-Fi network and works as an Access Point you can connect your PC to.

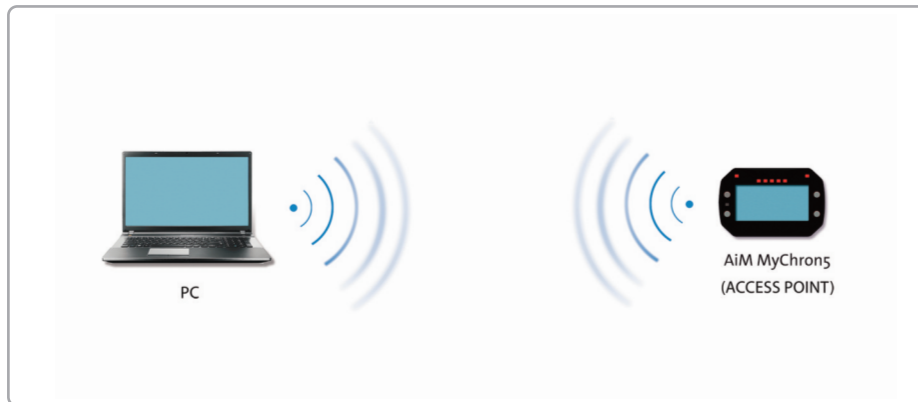

### 2 – Existing network (to connect to an existing Wi-Fi network – WLAN)

This mode is more complex and implies an external access point (AP) but it is also more flexible and powerful because allows you to communicate with more than one device and with more than one computer in the same network. MyChron5 and the PC must connect to an existing Wi-Fi network made by a device that works as an external Access Point.

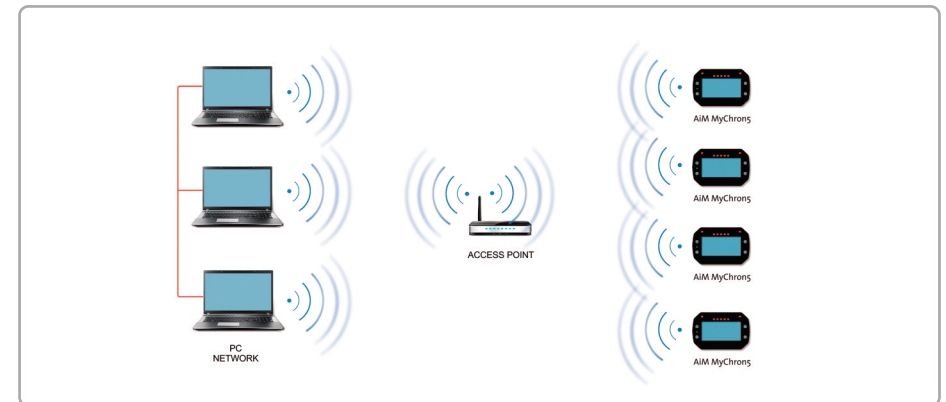

When working in WLAN mode MyChron5 has two available security levels:

- network authentication: network password
- device authentication: MyChron5 password

Both levels allow you to use different strategies. A PC in WLAN, for example, can see several AiM devices but can communicate only with those he knows the password of. If you forget the password you can reset Wi-Fi configuration from MyChron5 menu as explained at the beginning of this chapter.

## 4.6.1 Configuring MyChron5 as an Access Point (AP)

This is MyChron5 default configuration and is the easiest and most direct connection mode, ideal if you want to communicate with one MyChron5 using one PC. It is free and so completely accessible by anyone. Please set an access password as soon as possible.

To establish a Wi-Fi connection:

- ensure that the Wi-Fi is enabled
- read your MyChron5 name in the bottom line of the display main page (000101 in the image below).

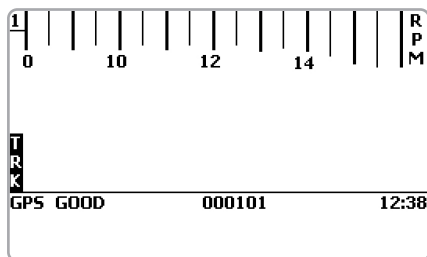

- run Race Studio 3
- click Wi-Fi icon and select your device
- in a few seconds, the connection is established

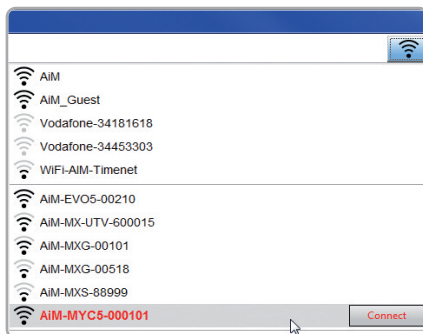

To set other parameters create a unique password to protect your device/your network. With a password, the communication is safe and encrypted using WPA2-PSK standard.

Characters allowed in the password are all letters, also capital, all digits and these characters: '+- \_()[]{}\$£!/?^#@\*\\"=~/:;/%"

"Space" type can be used if it is not the first one because this could cause incomprehension in some Windows™ versions.

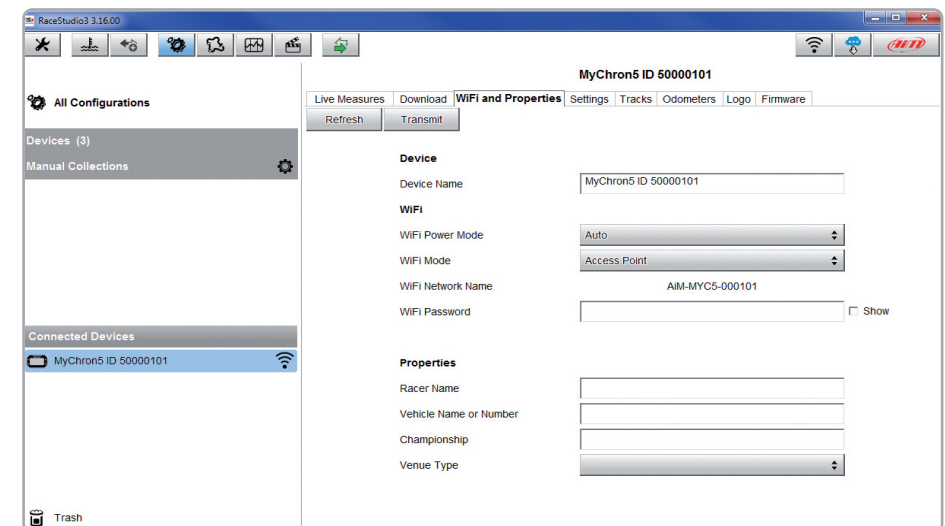

This AP or SSID name is unique for your device.  
An example of name is: "AiM-MYC5-000101" where:

- "AiM" is the prefix of all AiM devices
- "MYC5" is the device identifier
- "000101" is your device serial number assigned by the factory.

To make your device more recognizable you can add a name to the SSID. The limit is of eight characters. Allowed characters are all letters, capital too, all digits and these characters: '+ - \_ () [] {}!'.

"Space" type can be used provided that it is not the first one because it can cause incomprehension in some Windows™ versions.

If, for example you add the driver's name, Tom Wolf, the network name (SSID) becomes:

**" AiM-M5-000101-TomWolf"**

Once all parameters set click "Transmit". MyChron5 reboots and is configured with the new parameters. If MyChron5 is protected by a password, as recommended, Race Studio 3 will ask that password to authenticate.

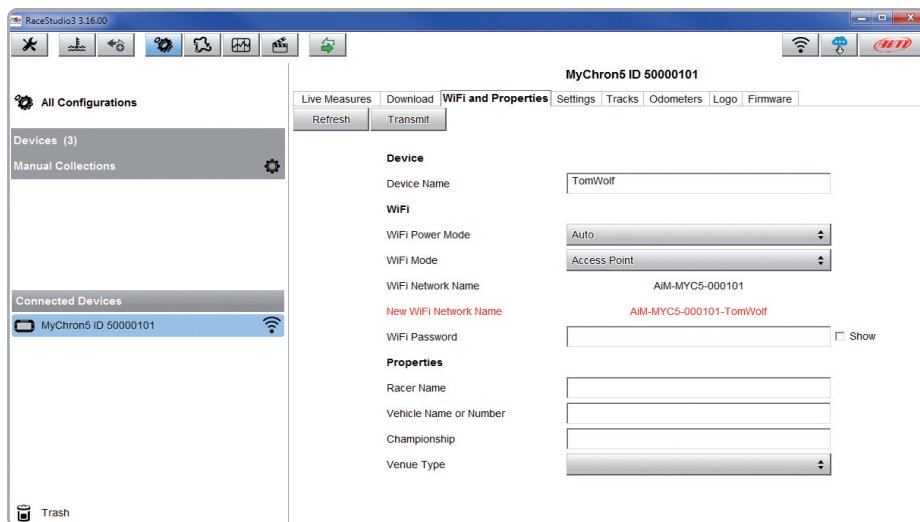

**Please Note:** the same Wi-Fi connection can be created with the operative system tool. Once the device has been authenticated in the Wi-Fi network you can communicate with it using Race Studio 3.

## 4.6.2 Adding MyChron5 to an existing network

This situation is ideal for a team with multiple drivers and staff members and is desired to communicate with one or more AiM devices using the same PC network. Each MyChron5 can have its password that adds another security and privacy level to the network.

Race Studio 3 will show all MyChron5 connected to the same network under "Connected devices" label, bottom left of the software page: click your device.

Enter "Wi-Fi and properties" tab and set it on "Existing Network"; fill in network name, network password and device password.

Transmit the network settings to your device clicking "Transmit": your device reboots and joins that network.

**Please note:** the only admitted password are those following WPA2-PSK standard.

To complete this procedure use Race Studio 3 software as here explained.

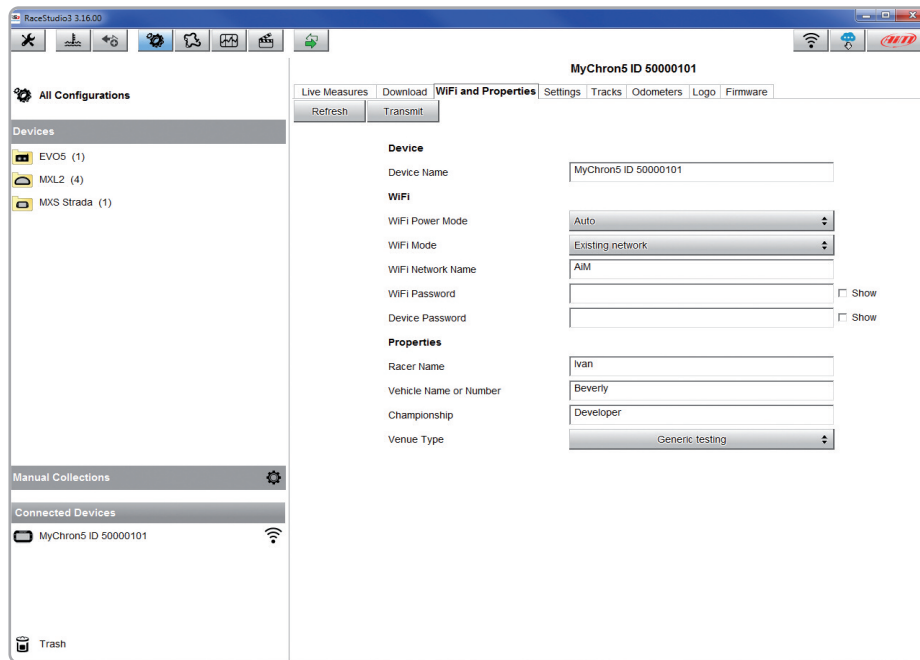

Here above you see a device “MyChron5 ID 50000101” that switched from WLAN AP mode (“Existing Network”).

Network name is “AiM” and does not work with free access because is protected by a password.

To obtain connectivity on the device the PC has to be authenticated to the same network as shown here below.

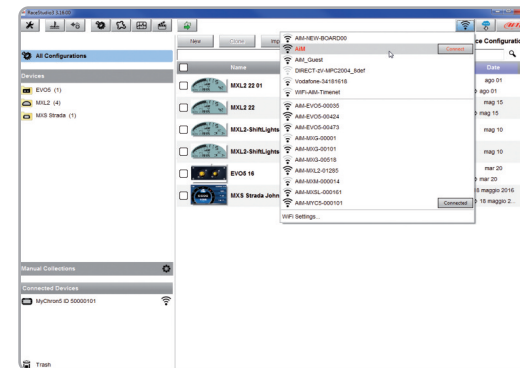

When the PC is authenticated to the network called “AiM” it can see all devices you configured to access the same network. In the image below two AiM devices are connected to the same “AiM” WLAN.

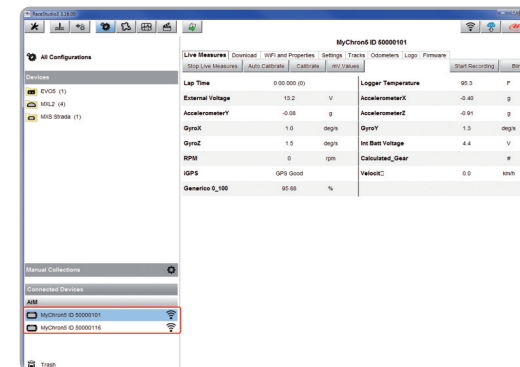

## 4.6.3 Wi-Fi network settings

In this chapter, you find a short description of how to configure a WLAN including AiM devices and a PC.

Here below is an example of configuration.

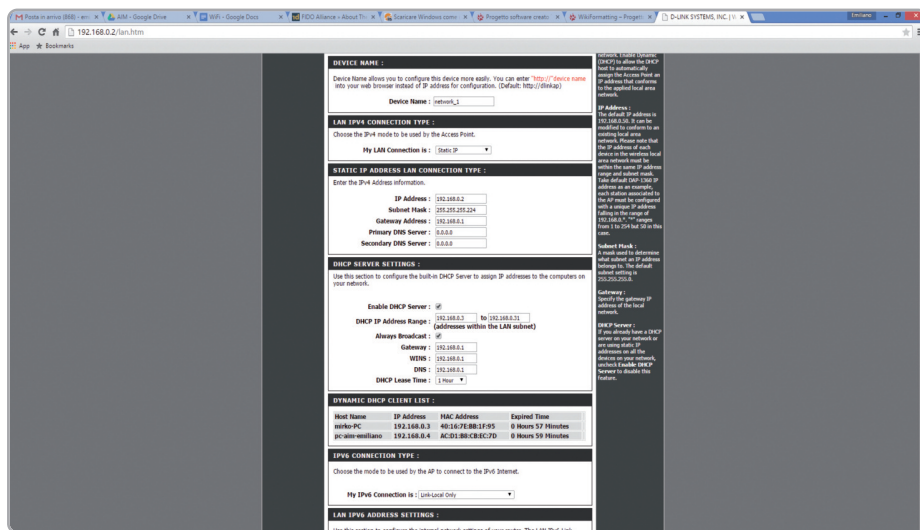

For better network performances, we suggest the use of a network device equipped with a DHCP server and using 3x3 MIMO technology like, for example a Linksys AS3200.

To maximize the bandwidth, you should not allow the Internet on this WLAN; this means the DHCP server should be configured without any DNS address nor gateway by default.

The parameters for the device network configuration in this example are:

### ■ **Wireless network name: network\_1**

It means that the WLAN network name is “network\_1.” A PC has to be authenticated in this network to interact with any AiM device of this network.

### ■ **Gateway address: 192.168.0.1**

primary DNS server: 0.0.0.0

secondary DNS server: 0.0.0.0

(These settings prevent Internet connectivity on this WLAN.)

### ■ **Subnet mask: 255.255.255.248**

Enable DHCP server: yes

DHCP IP address range: 192.168.0.2 to 192.168.0.6

These settings enable a DHCP server running on this WLAN and provide an IP address in a 2-6 range. This means that this network allows 5 network hosts.

The number of devices on a WLAN network depends on the subnet mask. Here below you see typical examples of network masks and IP addresses range.

The configuration in bold is the one we suggest (if a greater number of devices is not needed), being the one that makes it easier and quicker for Race Studio 3 the identification of the devices in the network.

#### **Subnet mask:**

255.255.255.0  
255.255.255.128  
255.255.255.192  
255.255.255.224  
255.255.255.240  
**255.255.255.248**

#### **IP address range:**

192.168.0.1 – 254  
192.168.0.1 – 126  
192.168.0.1 – 62  
192.168.0.1 – 30  
192.168.0.1 – 14  
**192.168.0.1 – 6**

#### **Number of devices:**

254  
126  
62  
30  
14  
**6**

## 4.6.4 The Internet connectivity

For an optimal speed of your AiM device(s) we recommend not to allow the Internet on the same network and to set the WLAN in the same way.

You can of course allow the Internet access on your network but this would degrade the communication.

This slightly slower speed can be suitable for your needs but you can also have a second Wi-Fi connection using an additional hardware (NIC).

This configuration would provide an optimal speed of the data network of your AiM device(s) and at the same time would provide an internet connectivity with the second NIC.

## 4.6.5 Connection issues

It can occur that MyChron5 is correctly connected to Race Studio 3 via Wi-Fi but the user interface does not show it. This may be because Wi-Fi port setting is set with a static IP. To switch it to dynamic (DHCP):

- open "Network and sharing centre" in the Windows™ research engine
- right click on the Wi-Fi connection and a panel shows up
- select "Properties" option
- double click on "Internet Protocol version 4 (TCP/IPv4)"
- verify that option "Obtain an IP address" is active

For further information refer to FAQ section, MyChron5 Wi-Fi of [www.aim-sportline.com](http://www.aim-sportline.com).

## 4.6.6 Working on Mac™ with virtualized Windows™

Race Studio 3 only works on Windows™ operative systems; Mac users can use a virtualized Windows™ machine.

The main problem is that the host OS (Mac) must share its Wi-Fi interface with the virtualized operative system (Windows) as Ethernet interface and not as Wi-Fi interface.

### Configuring Parallels(™)

Select "Configure..." in Parallels "Menu".

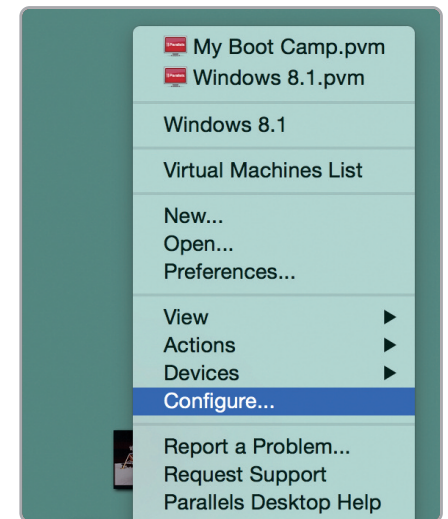

Press "Hardware" – top on the page that shows up – and select "Network" in the drop-down menu on the left.

Right on the configuration panel set "Type" field on "Wi-Fi".

Then select the device you want to communicate with.

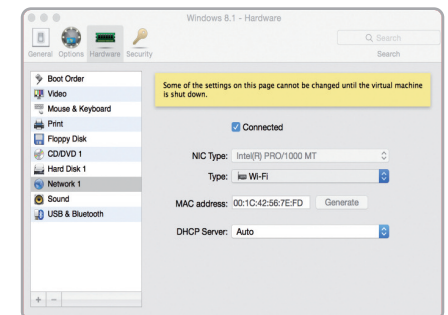



To ensure that the communication works select “Open Network preferences...” menu.



Verify that the status in the window that shows up is “Connected” and that the IP address associated is, for example, 10.0.0.10 (could be 10.0.0.11, 10.0.0.12, or generically 10.0.0.x).

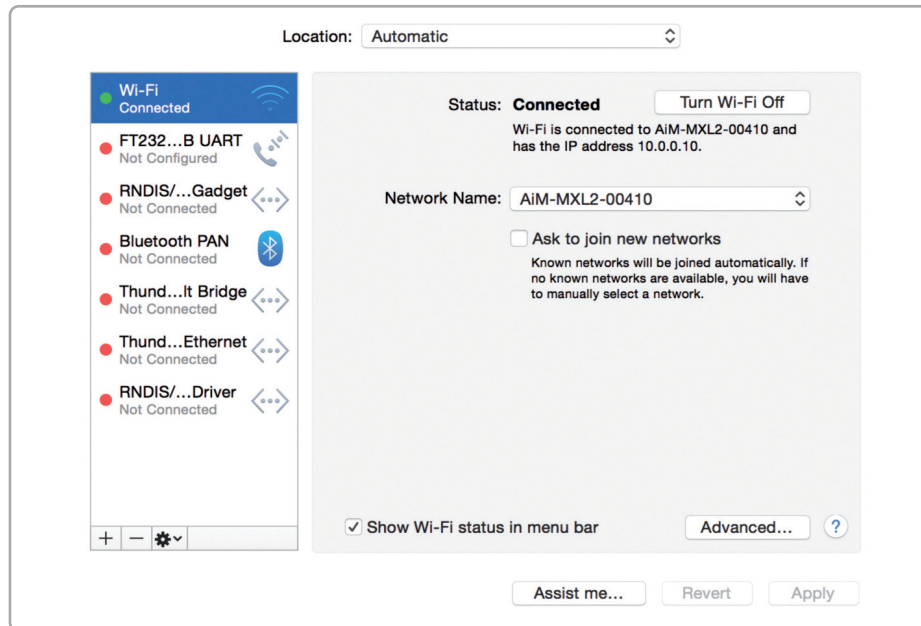

To enable Race Studio 3 correctly working on a Mac with virtualized Windows™:

- press Wi-Fi icon
- select “Wi-Fi Settings...” icon

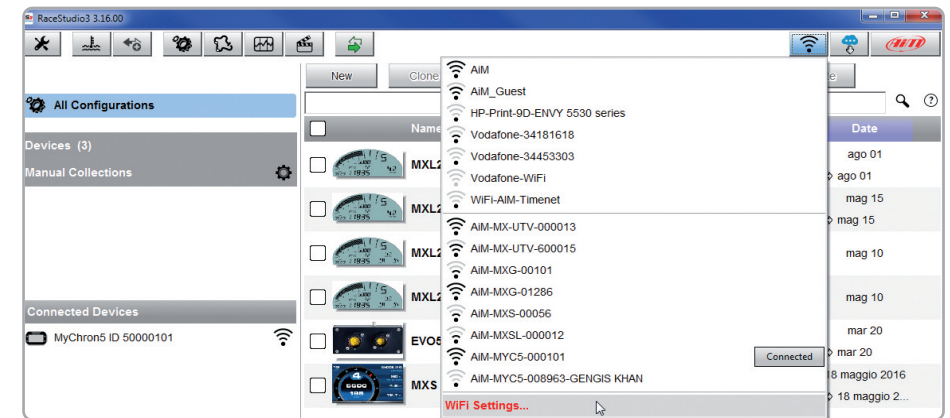

- enable the checkbox shown here below.

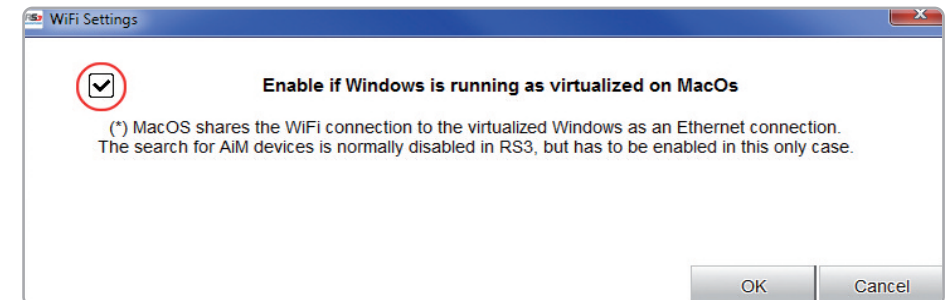

### 4.6.7 Connected device visualization issues

It may occur that using Race Studio 3 on an iMac with virtualized Windows the device connected via Wi-Fi takes some time to be shown in the network or is not shown at all.

This is why we always suggests using an Wi-Fi (WLAN) router.

This router work as an Access Point allowing more external devices to connect to its network. MyChron5 Wi-Fi configuration is to be set on Existing Network as explained in the related paragraph.

## 4.7 GPS and Track management



MyChron5 built-in GPS receiver is used for:

- Lap Time calculation
- Speed calculation
- Predictive lap time calculation
- Position on the track in analysis

To calculate these data the system needs the following information about the racetrack:

- start/finish line coordinates
- possible magnetic strips coordinates

MyChron5 comes with a long list of the world main kart tracks. The tracks are constantly updated by our technicians and are automatically loaded to your PC when you run our Analysis Software Race Studio3 and a connection to the Internet is available.

MyChron5 provides two track selection modes: automatic and manual.

#### Automatic:

MyChron5 automatically recognizes the track you are running on, loads the start/finish line and the possible splits coordinates and calculates lap and split times without optical/magnetic receiver.

This is the best mode in most cases.

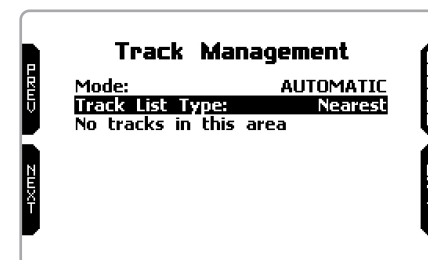

**Manual:**

allows to manually select the track from the internal database.

This mode is to prefer when multiple track configurations are available nearby. In this case MyChron5 would anyway recognize the track but would need at least one complete track lap.

To be ready from the first lap manual mode would be helpful.

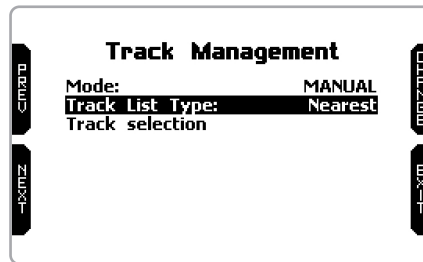

You can scroll the list of available tracks choosing among these options:

- nearest: shows only tracks in a 10 km distance
- all: shows all tracks stored in the system in alphabetical order
- custom: shows only the tracks you have previously created (learning mode)

### 4.7.1 Creating a track with MyChron5

If you are running in a track NOT included in MyChron5 database the device switches to “learning” mode and behave this way:

- it starts sampling all track points
- when detects that is crossing the same points for the second time it realizes that the track is closed and sets a temporary start/finish line showing lap time each time it crosses that point;
- at the end of the session the system shows the track map with start/finish line: you can move start/finish line using MyChron5 lateral buttons
- you can add this new map to MyChron5 database, modify start/finish line coordinates, name the track and transmit it to the PC at first PC-MyChron5 connection.

For further information about track management with Race Studio 3 refer to “Track Manager” user manual you find in download area /software/Race Studio 3/documentation of [www.aim-sportline.com](http://www.aim-sportline.com).

## 4.8 Language

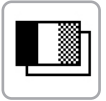

You can set MyChron5 language; default setting is English. At present available languages are (in this order):

- English
- Italian
- Deutsch
- Spanish
- French
- Dutch
- Dansk
- Portuguese
- Japanese

### 4.8 Clear memory



Clears all sessions stored in MyChron5 memory: needs confirmation.

## 5. On the track

Some MyChron5 pages are available for online visualization.

To scroll them press "ON/VIEW".

Pages can change according to the device configuration: go kart or shifter kart, possible expansions, SmartyCam, etc.

At least two pages are always available:



### Selected track page:

it is the first page that appears switching MyChron5 on.

When the kart is moving, this is automatically closed. It shows:

- on the left, the selected track; you can select a new track manually (menu/track management) or automatically.

- on the right, the satellite bar (visible satellites and signal level of each one).

To recall it press (">>/OFF") button in correspondence of "TRK" label in MyChron5 home page.

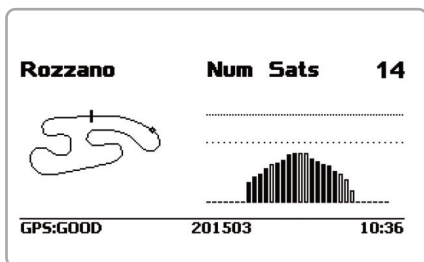

### RPM&LAP TIME page:

shows:

- RPM bar graph whose range has been set in "RPM setup"
- RPM value on the right of the display
- Temperature value(s) on the left part of the screen
- lap time information (actual, rolling or predictive). This information is shown for the period you set in "Lap time setup"

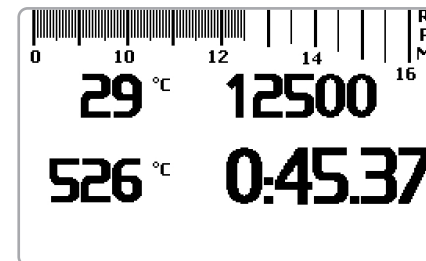

### SPEED&LAP TIME page:

Like the previous one but with speed shown on the right.

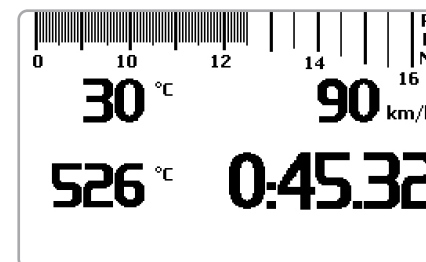

## 6. Data Recall

At the end of the test you can recall sampled data pressing **MEM/OK**.

**Data recall is different according to your MyChron5 version and to the available types of race.**

In the European version, the only available racing mode is:

- road

In the US version, the racing modes can be:

- road
- oval

### 6.1 Data recall in Road racing mode

In Road racing mode data recall shows these pages.

If your last test is at least 24 hours old you can enter summary page and select the day you want to see.

Press "ENTER"

TEST SESSIONS	
27/09/2015: <b>Rozzano</b>	
26/09/2015: <b>Rozzano</b>	
25/09/2015: <b>Lonato</b>	

Then select the test.

In each box you see test time, laps number and the best lap time.

Press "ENTER"

25/09/2015: <b>Lonato</b>					
15:10	15:01	14:10			
6 0:42.07	10 0:42.73	6 0:42.78			
14:01	12:42	12:40			
10 0:42.68	5 0:42.51	3 0:43.02			

If you just finished your test the first page you see is the one here on the right.

It shows the three best lap times with max/min RPM values, speed and temperature.

Press "NEXT".

27/09/2015 13:31					
Lap	Best Laps	RPM	Kmh	T2	
<b>7</b>	<b>0:50.06</b>	14008 7234	107 49	61 59	
<b>9</b>	<b>0:50.08</b>	13963 6953	107 46	60 58	
<b>11</b>	<b>0:50.13</b>	14085 6811	107 49	59 58	

The page shows the three best split times only if they have been set in Race Studio 3 or detected by magnetic strips.

Press "NEXT".

Best Lap: <b>7 0:50.06</b>			Rozzano		
#	Split times				
<b>1</b>	<b>0:18.98</b>				
<b>2</b>	<b>0:18.22</b>				
<b>3</b>	<b>0:12.84</b>				

The page shows the three best splits, the best rolling lap time and the best theoretical lap.

This page is available only if split times (from GPS or magnetic strip) were previously set.

Press "NEXT"

Best Lap: <b>7 0:50.06</b>					
#	Split times	Lap	Rolling	Lap Theoretic	
<b>1</b>	<b>0:18.98</b>	14	<b>0:18.96</b>	14	<b>0:18.96</b>
<b>2</b>	<b>0:18.22</b>	13	<b>0:18.29</b>	7	<b>0:18.22</b>
<b>3</b>	<b>0:12.84</b>	13	<b>0:12.77</b>	13	<b>0:12.77</b>
	<b>0:50.06</b>		<b>0:50.03</b>		<b>0:49.96</b>

This page is a histogram test summary. Moving the cursor left and right you can see all laps and select the one you want to see. Press "ENTER".

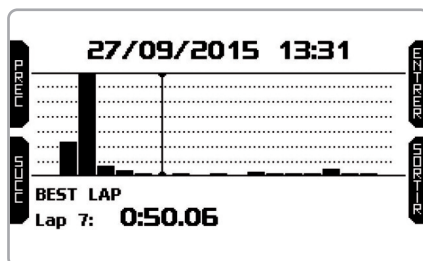

This page shows the RPM graph of the lap.

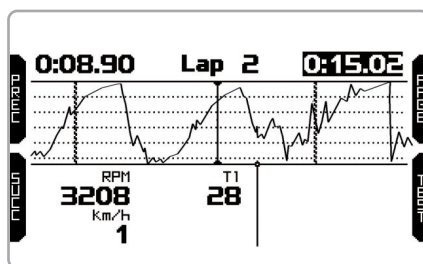

## 6.2 Data recall in oval racing mode (US version only)

In Oval racing mode data recall shows these pages. If your last test is at least 24 hours old you can enter summary page and select the day you want to see. Press "ENTER".

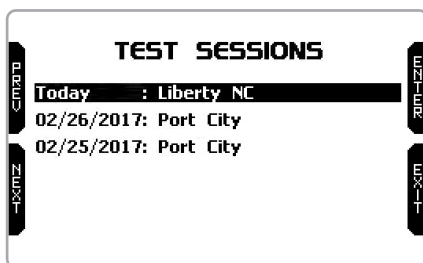

Now you can choose the test. In each box you see test time, number of laps, possible "yellow flag" laps and best lap time. Press "ENTER".

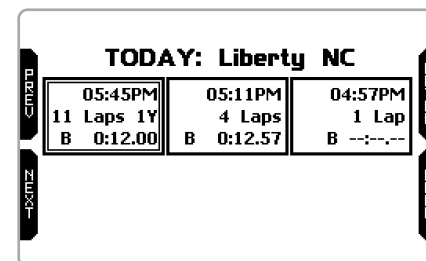

If you just finish the test the first page you see is the one here on the right. The page shows the three best laps of that test with max/min RPM values and RPM drop. Press "PAGE".

TODAY 05:45PM 1

MAX RPM	MAX SPEED		
6495	58.2		
Lap	Best Laps	RPM	DROP
9	0:12.00	6495 5966	529
7	0:12.04	6426 5931	495
8	0:12.06	6421 5930	491

This page is an histogram test summary. Moving the cursor right and left you can see all lap times. Bottom on the page you see best lap time, the selected lap and the difference between the selected lap and the best one. Laps labelled "Y" are "Yellow Flag" laps. Press "PAGE".

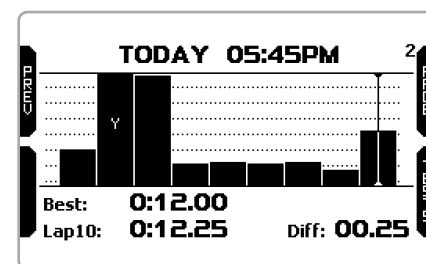

This page is a laps summary with the selected one highlighted. It shows lap times, max/min RPM values and RPM drop. Press "PAGE".

TODAY 05:45PM 3

Lap	Time	RPM	DROP
8	0:12.06	6410 5870	540
9	0:12.00 <sup>B</sup>	6495 5966	529
10	0:12.25	6012 5513	499

This page shows the lap playback with your vehicle that moves on the track. Press "SLOW" to reduce the vehicle speed. Press "PAGE".

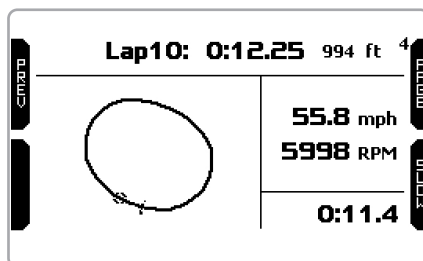

This page shows the lap sectors with max/min speed and related RPM values. Press "PAGE".

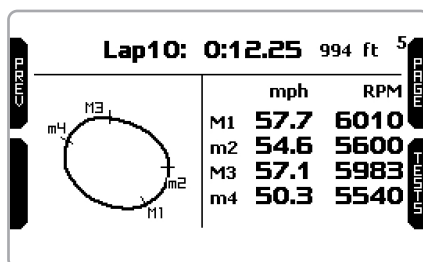

"Grip" page shows the lateral grip in feet/sec<sup>2</sup> of the two turns and the grip average value (AVG). Press "TESTS" to go back to test summary page.

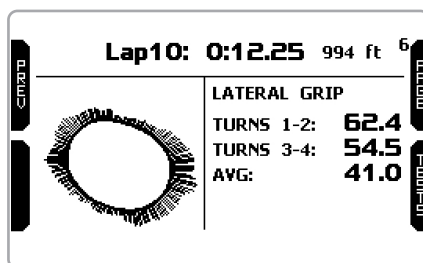

## 7. Connection to the PC

You can connect MyChron5 to a PC only via Wi-Fi. To do it:

- check that MyChron5 Wi-Fi is set on "AUTO" (all versions) or on "ON" (US version only)
- read your MyChron5 name – mid of MyChron5 home page bottom line – or look for it in "System Information" page.
- click Race Studio 3 Wi-Fi icon and select your MyChron5

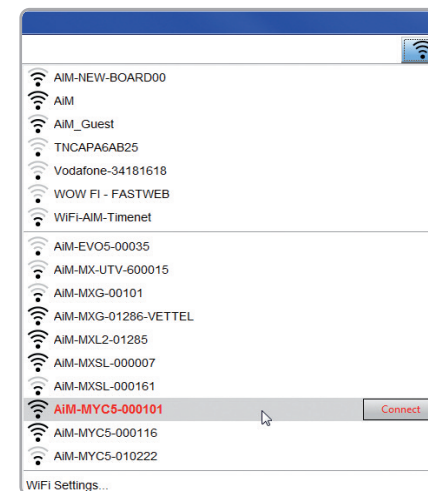
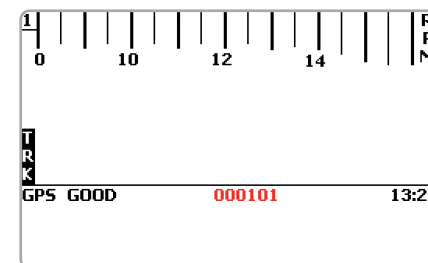

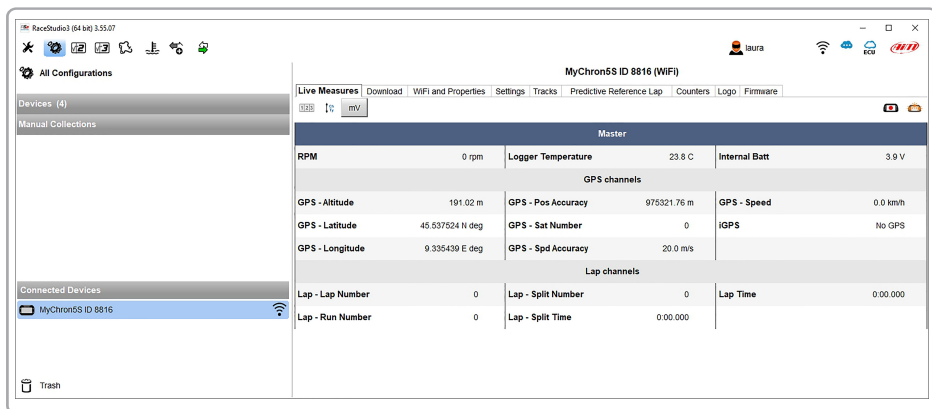

**Please note:** this view can change according to the features available when your MyChron5 has been produced.

Once the connection is established you have these options:

- **Live Measures:** to check all MyChron5 channels;
- **Download:** to download data, see the related chapter;
- **Wi-Fi and Properties:** to manage the Wi-Fi configuration – see the related chapter;
- **Settings to:**
  - set date format
  - enable/disable daylight time
  - set time format and time zone
  - set backlight colour
  - enable/disable night vision
- **Tracks:** to manage the tracks stored in the device memory
- **Odometers:** to manage the device odometers; here you can reset the four user odometers as well as name them;
- **Logo:** transmit/receive the logo that shows up when switching MyChron5 on; supported image format are JPEG or BMP; always use the most recent Windows™ versions (Windows8 or Windows10) whose graphic libraries are more updated
- **Firmware:** to check or update your MyChron5 firmware version.

## 8. Data download

Once MyChron5-PC connection is established activate “Download” tab to download sampled data.

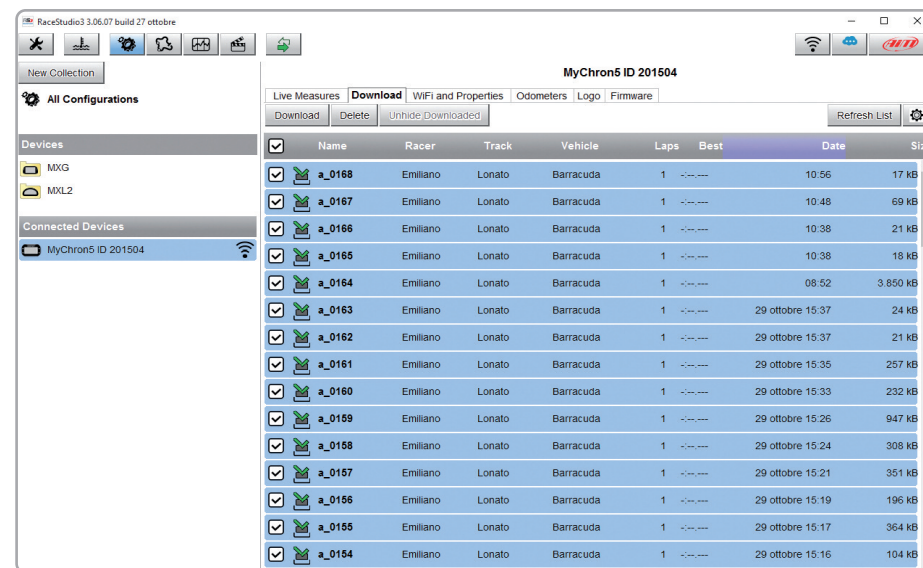

This page shows all information about the files stored in the system: number of laps, best lap, date/time and file dimensions. Select one or more files and press “Download” to download and analyse them.



## 9. Analysis

When data have been downloaded press Analysis icon and Race Studio Analysis software will open showing this page.

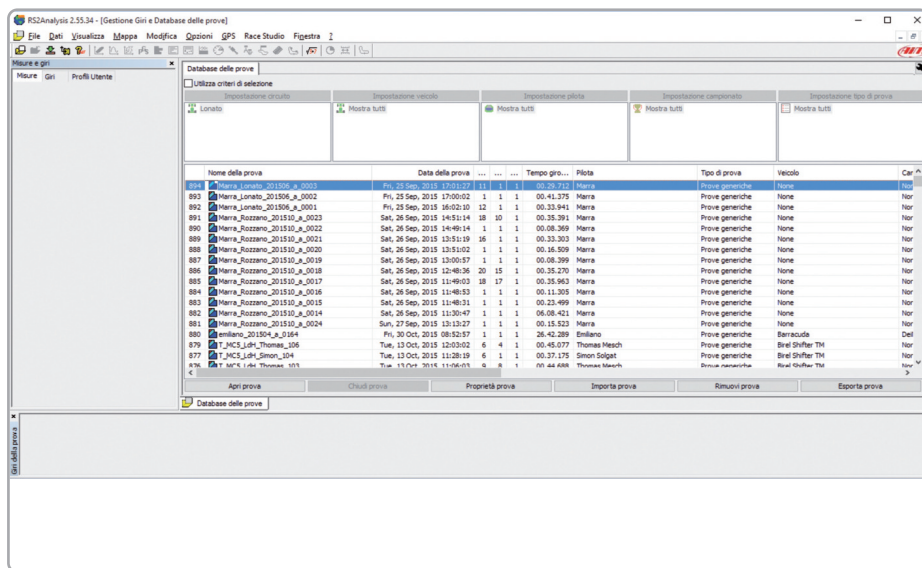

Select your file double clicking on it and start analysing it. A lot of pages, graphs and images will help you analysing your data in the best way.

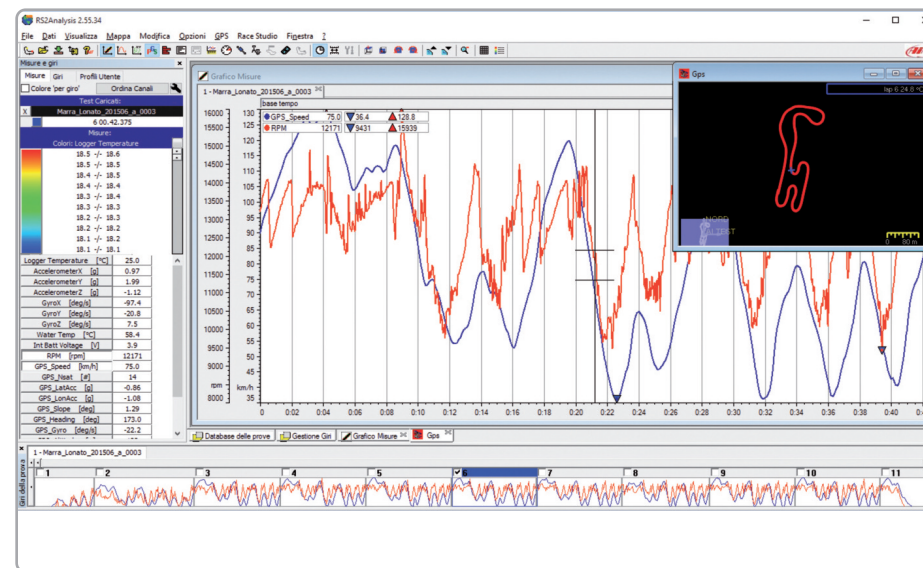

## 10. Notification of new available versions

Our technicians and engineers are constantly working to improve both the firmware (the application that manages your device) and the software (the application you install on your PC).

Each time a new firmware and/or software version is available the icon here above appears with an arrow indicating that something is available for download (otherwise the icon only shows the cloud).

Click it and freely download the new applications.

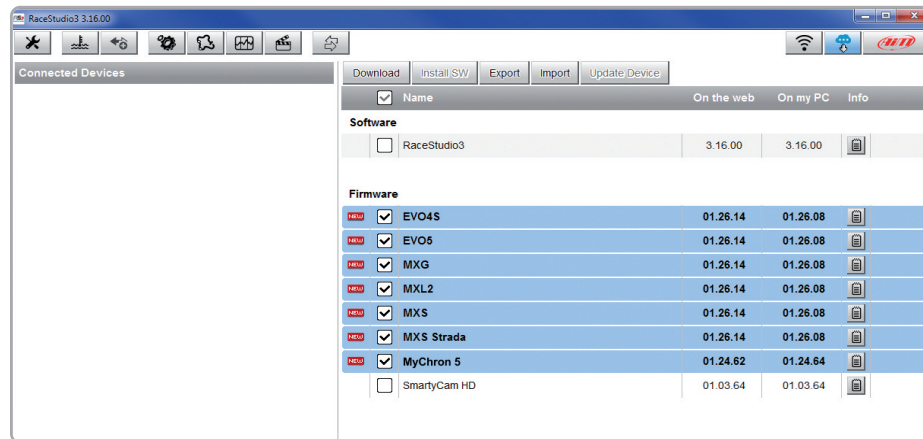

Once the new firmware has been downloaded, connect your device to the PC via Wi-Fi to perform a firmware upgrade. In a few seconds, the device is ready.





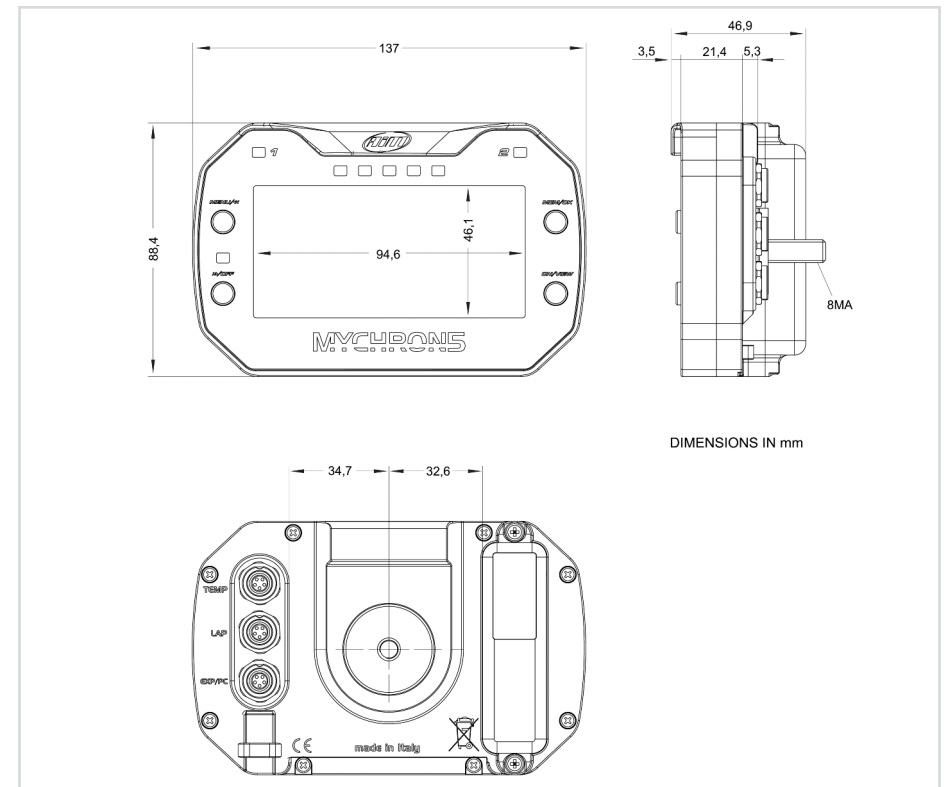

## 11. Technical specification and drawings

■ Integrated GPS	10 Hz GPS + Glonass
■ RPM	Up to 24.000 RPM
■ Temperature	Thermocouple/ Thermo-resistor
■ Lap time	Based on GPS (included) From Optical or Magnetic receiver (optional)
■ PC connection via Wi-Fi	Yes
■ Internal memory	4 Gb - more than 3.000 hours continuous logging
■ Display resolution	268x128 pixel
■ Backlight	Multi-colour
■ Alarms	2 Freely configurable RGB LEDs
■ ShiftLights	5 Freely configurable RGB LEDs
■ Battery	Rechargeable 2900 mAh Lithium Ion
■ Battery duration	Up to 10 hours
■ Battery charger	Included
■ Body	Nylon and fiberglass
■ Dimensions	137x88x30mm
■ Weight	390g battery included
■ Analysis software	Race Studio Analysis freely downloadable from <a href="http://www.aim-sportline.com">www.aim-sportline.com</a>

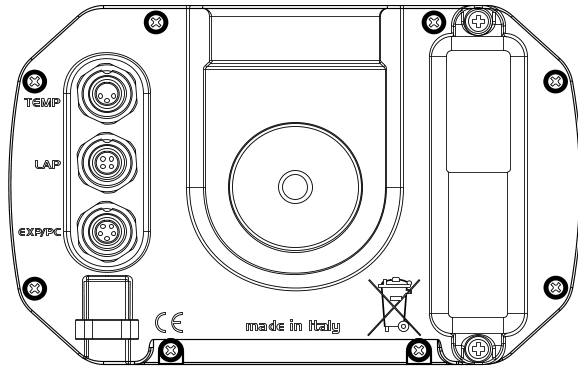





### Mychron5/MyChron5S pinout

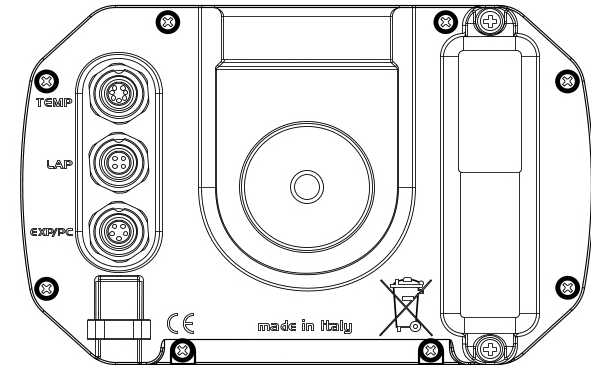

TEMP 3 pins Binder 712 female connector (external view)	LAP 4 pins Binder 712 female connector (external view)	EXP/PC 5 pins Binder 712 female connector (external view)
 <p>1 - Thermocouple 2 - GND 3 - Thermo resistor</p>	 <p>1 - Magnetic Lap 2 - GND 3 - +Vbattery 4 - Optical Lap</p>	 <p>1 - CAN+ Exp 2 - GND 3 - +Vbout CAN 4 - CAN- Exp 5 - +Vbext CAN</p>

### Mychron5 2T/ MyChron5S pinout



TEMP 7 pins Binder 712 female connector (external view)	LAP 4 pins Binder 712 female connector (external view)	EXP/PC 5 pins Binder 712 female connector (external view)
 <p>1 - Thermocouple 1 2 - GND 3 - Thermocouple 2 4 - GND 5 - Thermo resistor 1 6 - GND 7 - Thermo resistor 2</p>	 <p>1 - Magnetic Lap 2 - GND 3 - +Vbattery 4 - Optical Lap</p>	 <p>1 - CAN+ Exp 2 - GND 3 - +Vbout CAN 4 - CAN- Exp 5 - +Vbext CAN</p>

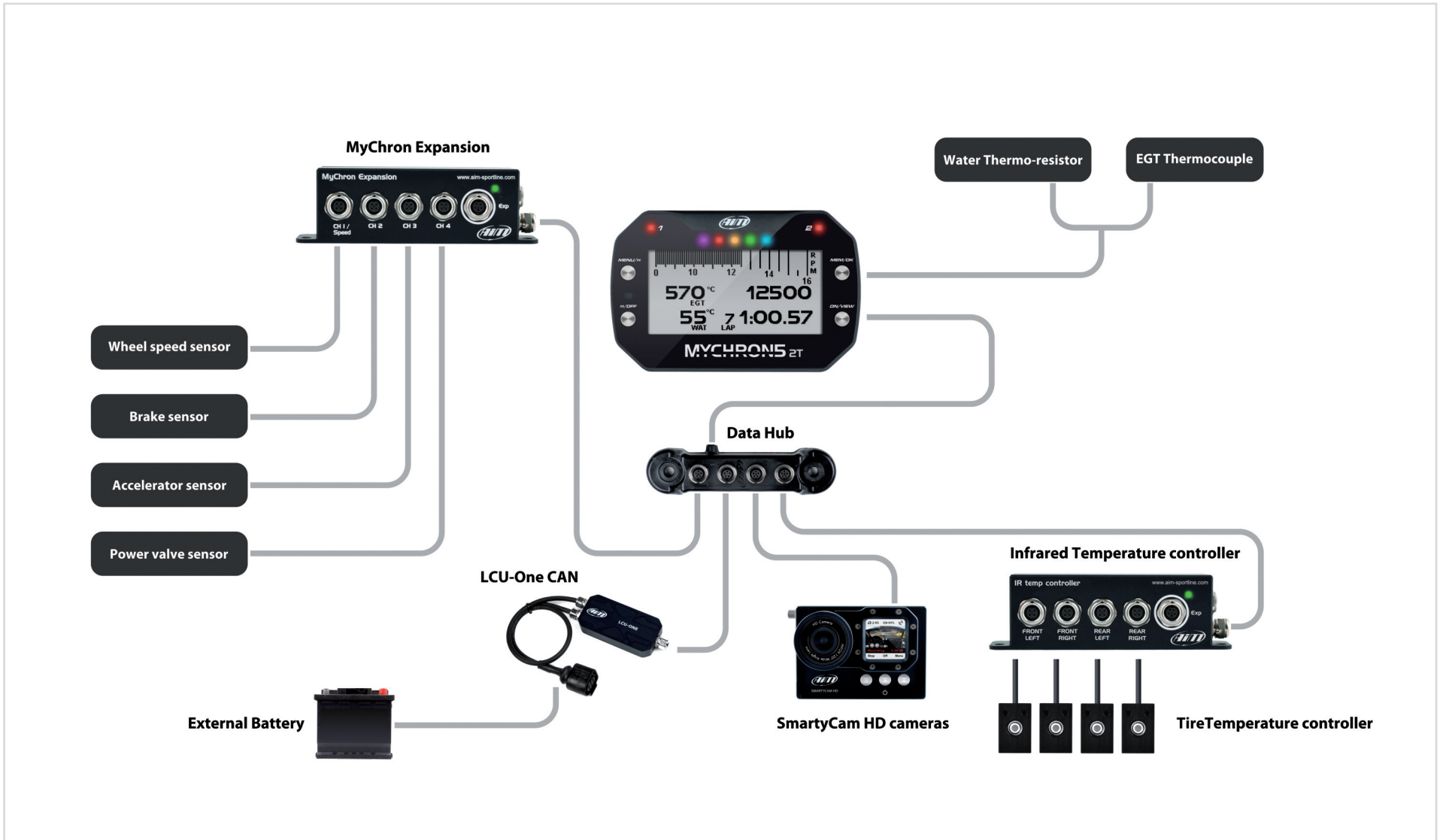



Our web site, [www.aim-sportline.com](http://www.aim-sportline.com) is constantly upgraded. Please, refer to it for downloading the last release of our documentation

